

END ELEVATION

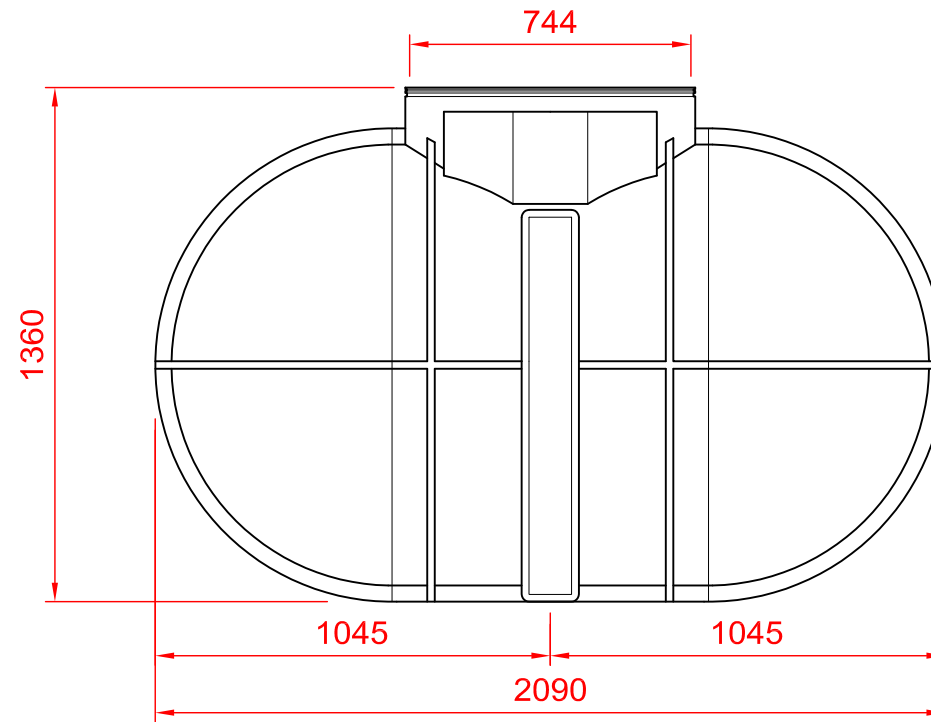

SIDE ELEVATION

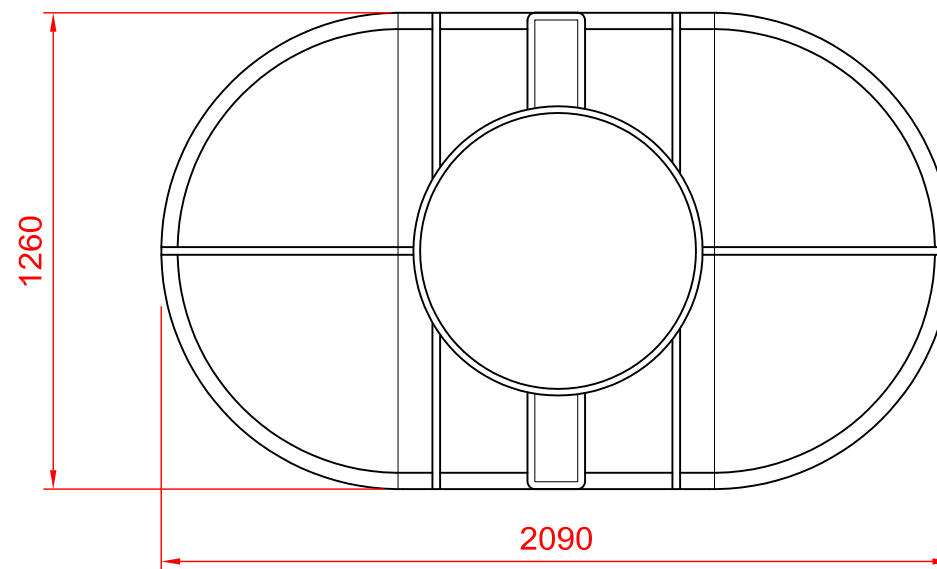

PLAN

© Atlantis Tanks Group Ltd. 2020



Title  
**1800 Litre Puratank  
 Plans and Elevations**

Scale  
**1:20**

---

Drawing No.  
**PUR-1800-01**

Revisions  
 -